

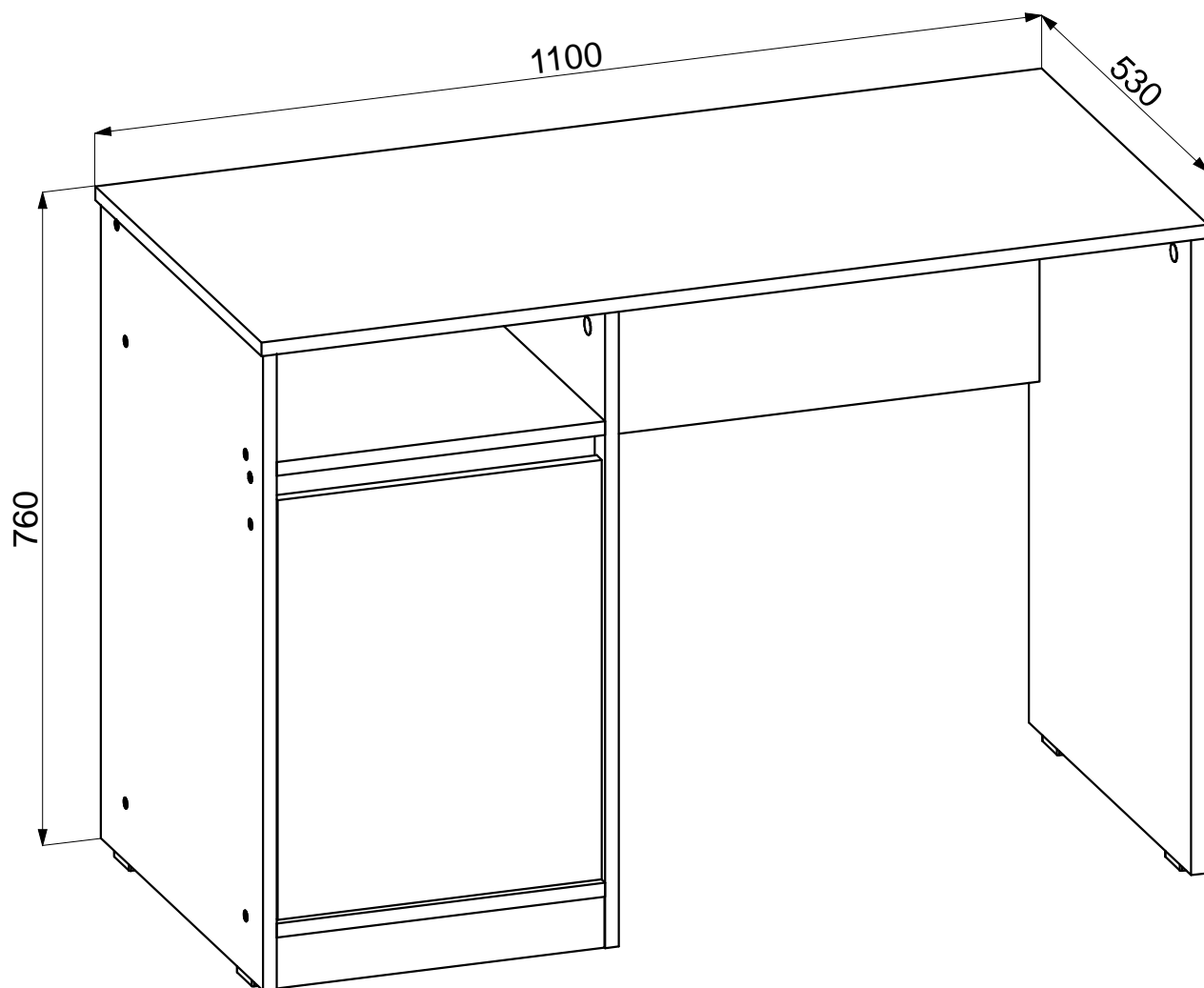







Бюро Ейдън



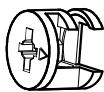
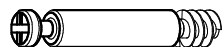

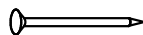

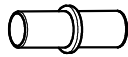
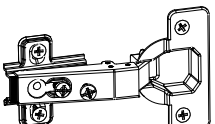
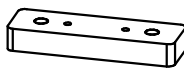
 Ø6,3x50 mm A1 x 19	 Ø12 mm A2 x 19	 4 mm A3 x 1	 Ø15x12 mm B1 x 8	 Ø5x44 mm B2 x 8
 Ø20 mm B3 x 8	 Ø4x16 mm D1 x 20	 Ø1,6x25 mm F x 45	 Ø8x36 mm G x 13	 Ø5x16 mm L x 4
 M x 2	 N x 6			

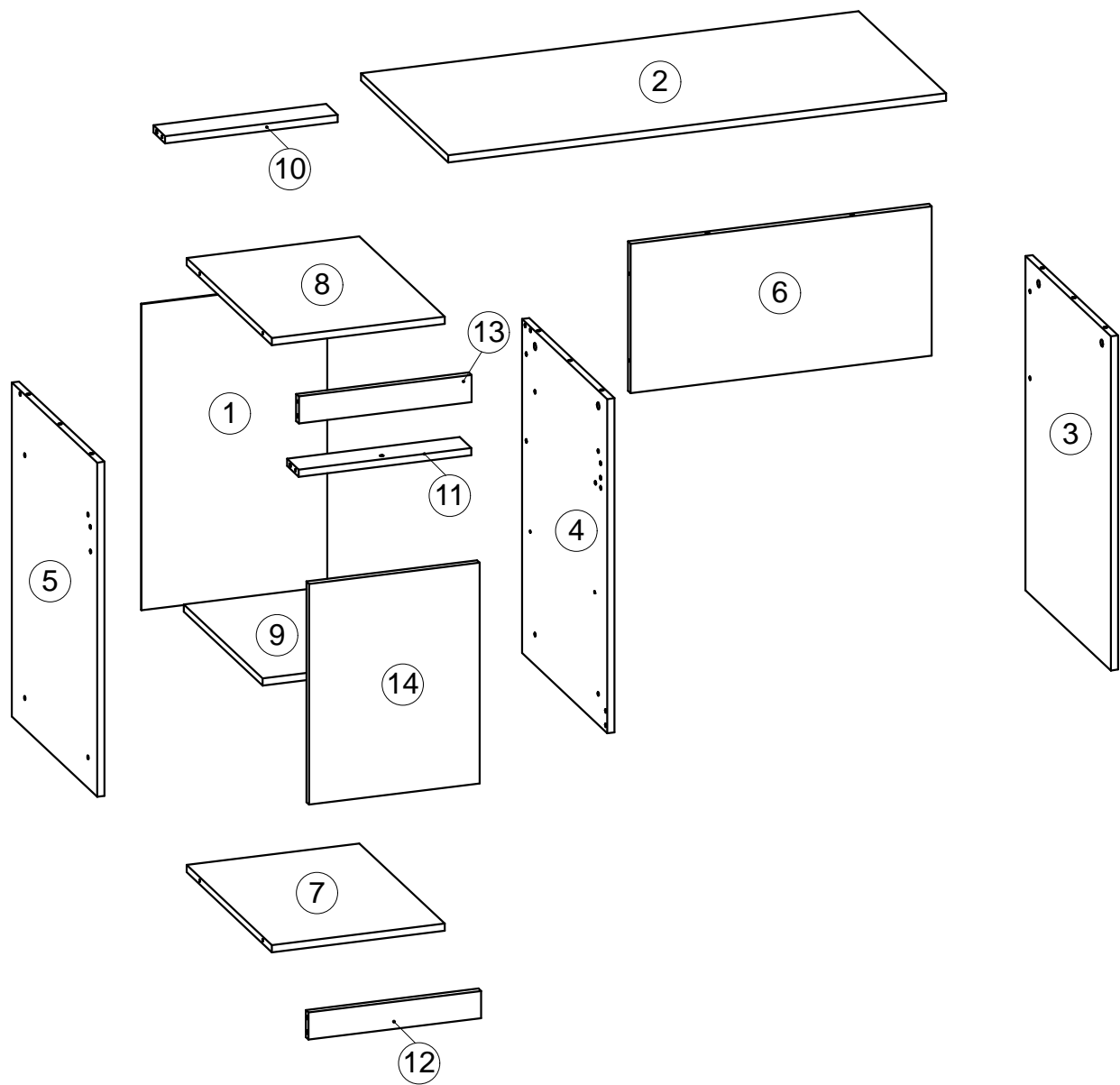

Box 1 / 2

677x411x3 mm

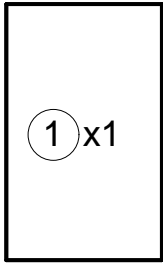

739x518x16 mm

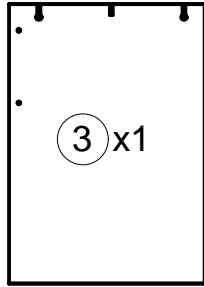

739x518x16 mm

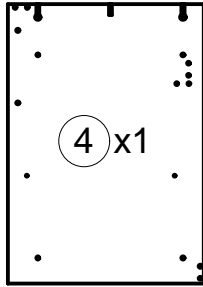

739x518x16 mm

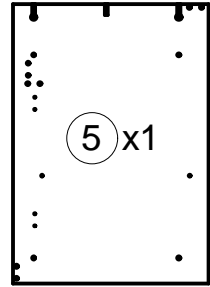

666x330x16 mm

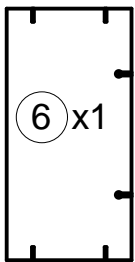

382x518x16 mm

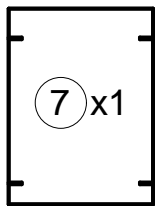

382x518x16 mm

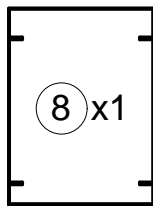

478x381x16 mm

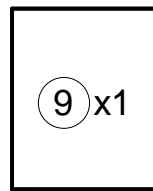

382x70x16 mm

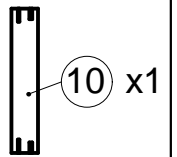

Fittings & Tools

382x70x16 mm

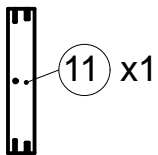

382x60x16 mm

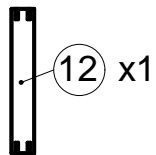

382x60x16 mm

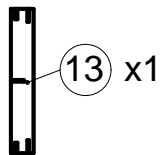

487x376x16 mm

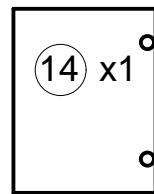

Box 2 / 2

1100x530x16 mm

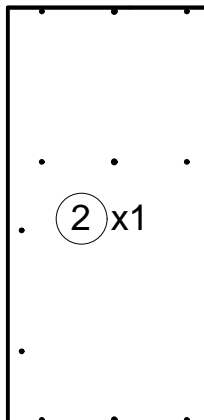

1

B2 x 8

G x 3

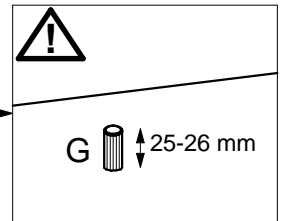
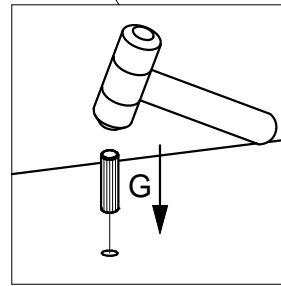
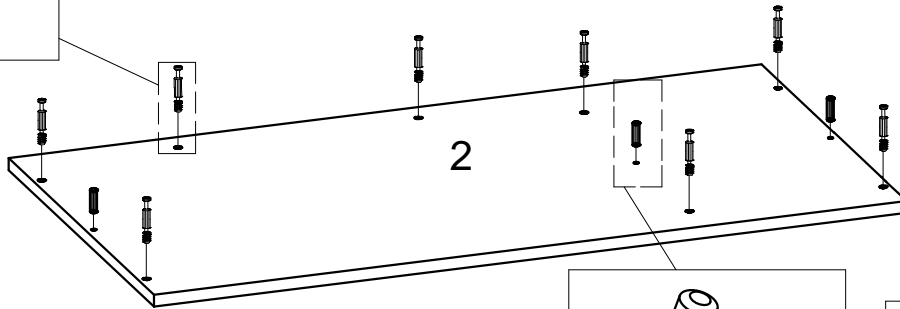
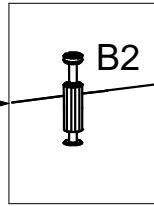
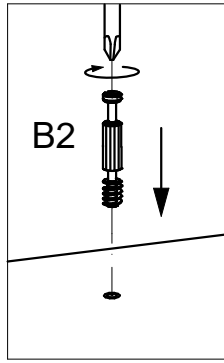
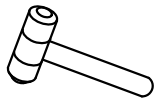
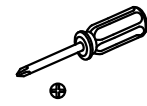

2



B1 x 2

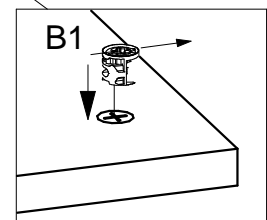
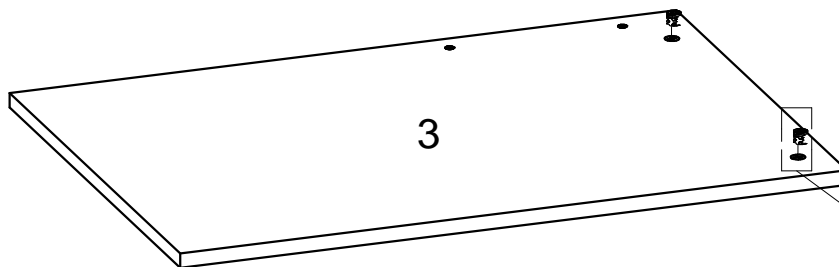
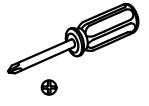

3



B1 x 2



G x 5



L x 2

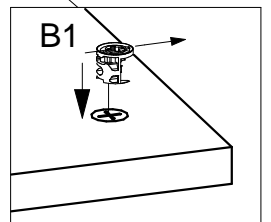
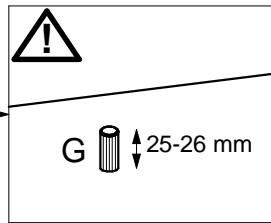
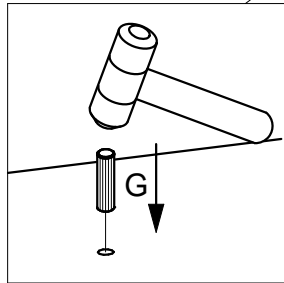
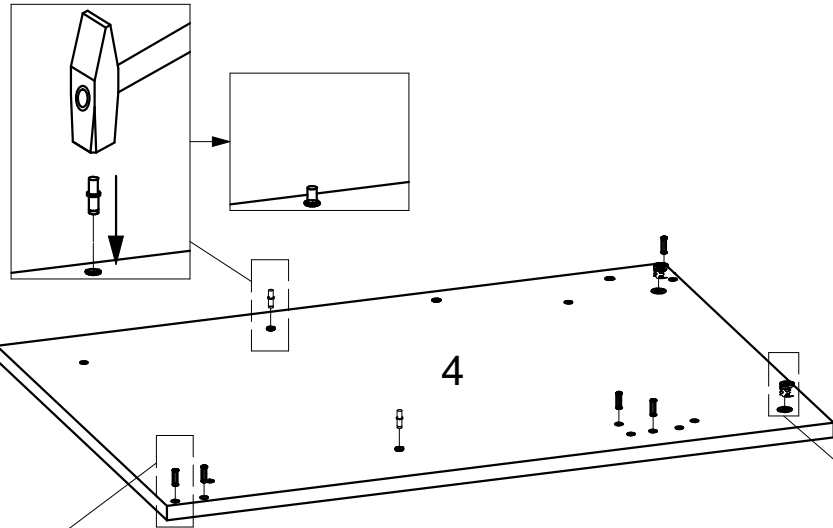
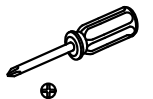
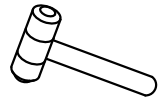

4



B1 x 2



D1 x 4



G x 5



L x 2



M.1 x 2

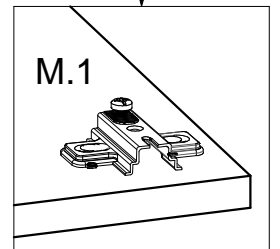
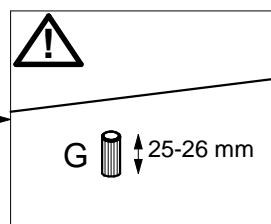
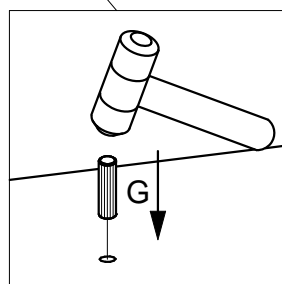
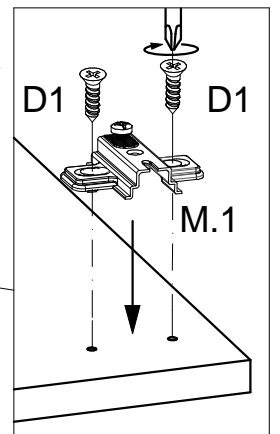
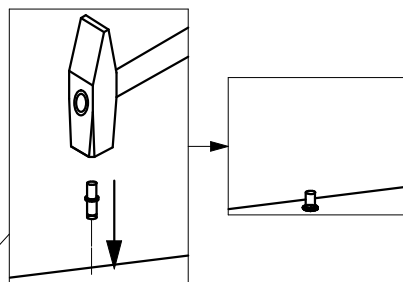
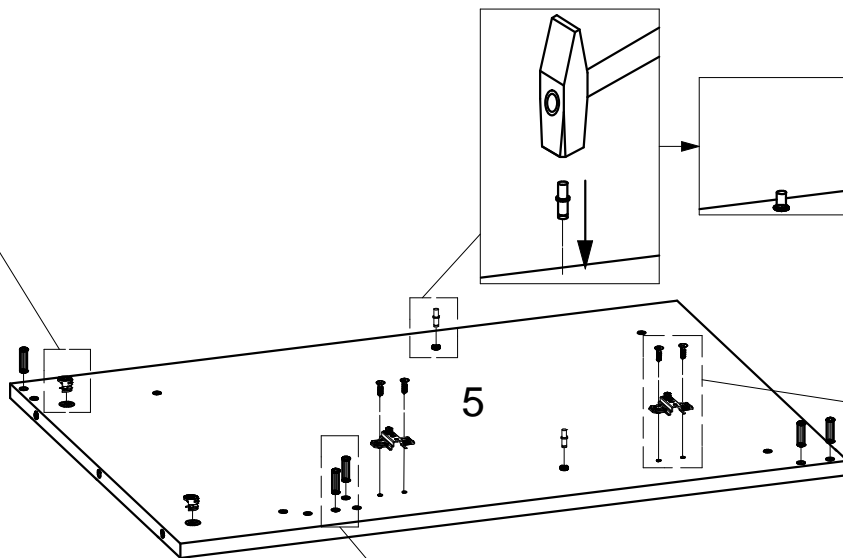
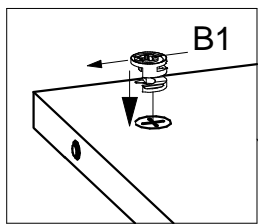
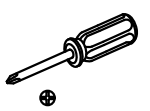
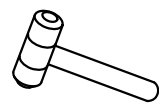
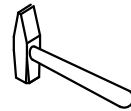

5



B1 x 2

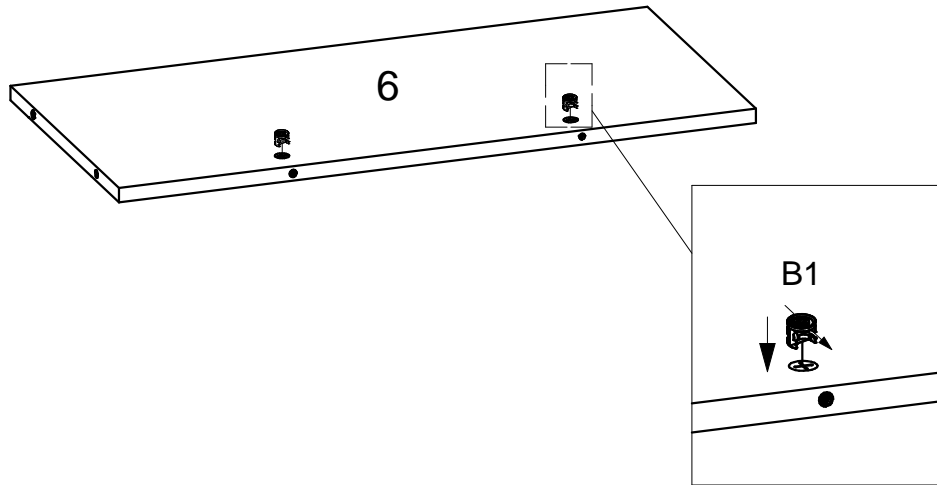
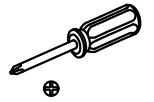

6



D1 x 4

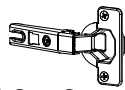

M.2 x 2

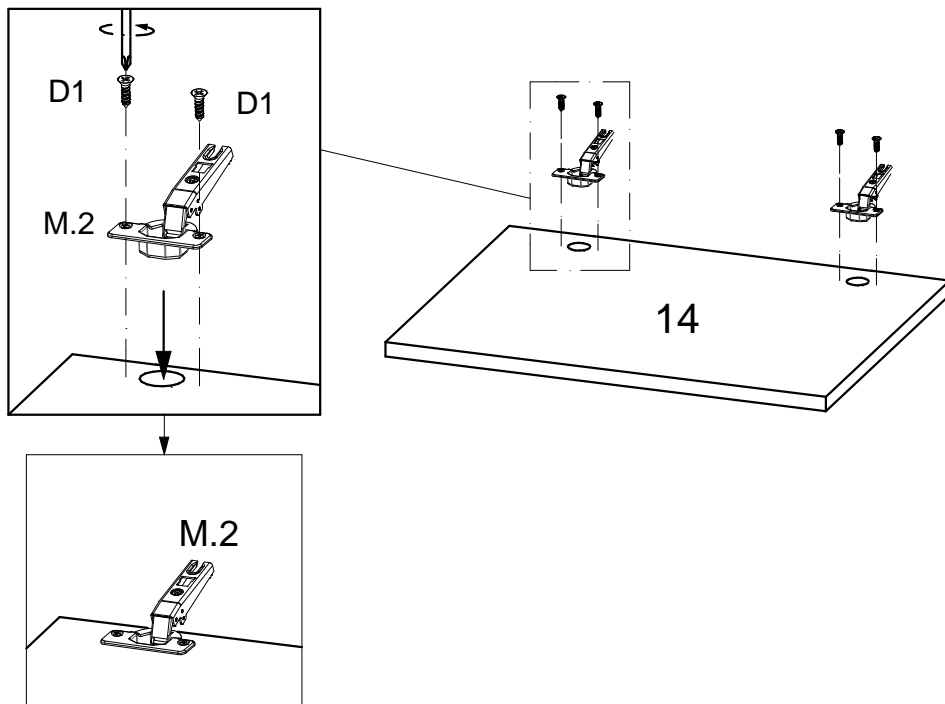
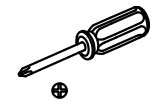

7

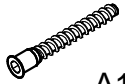

A1 x 1



A2 x 1



A3 x 1

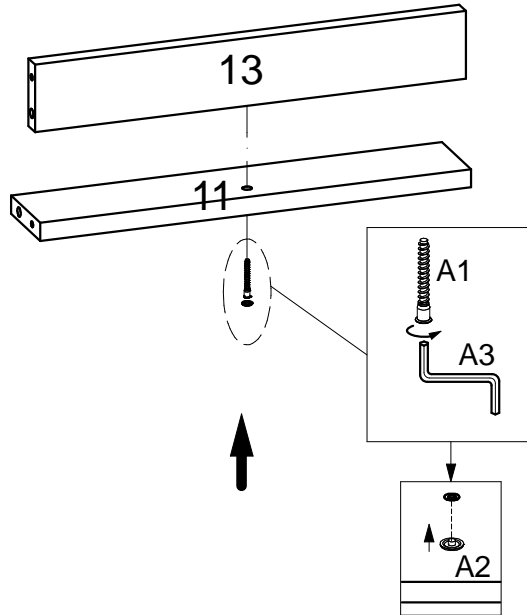

8

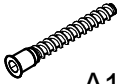

A1 x 14



A2 x 14



A3 x 1

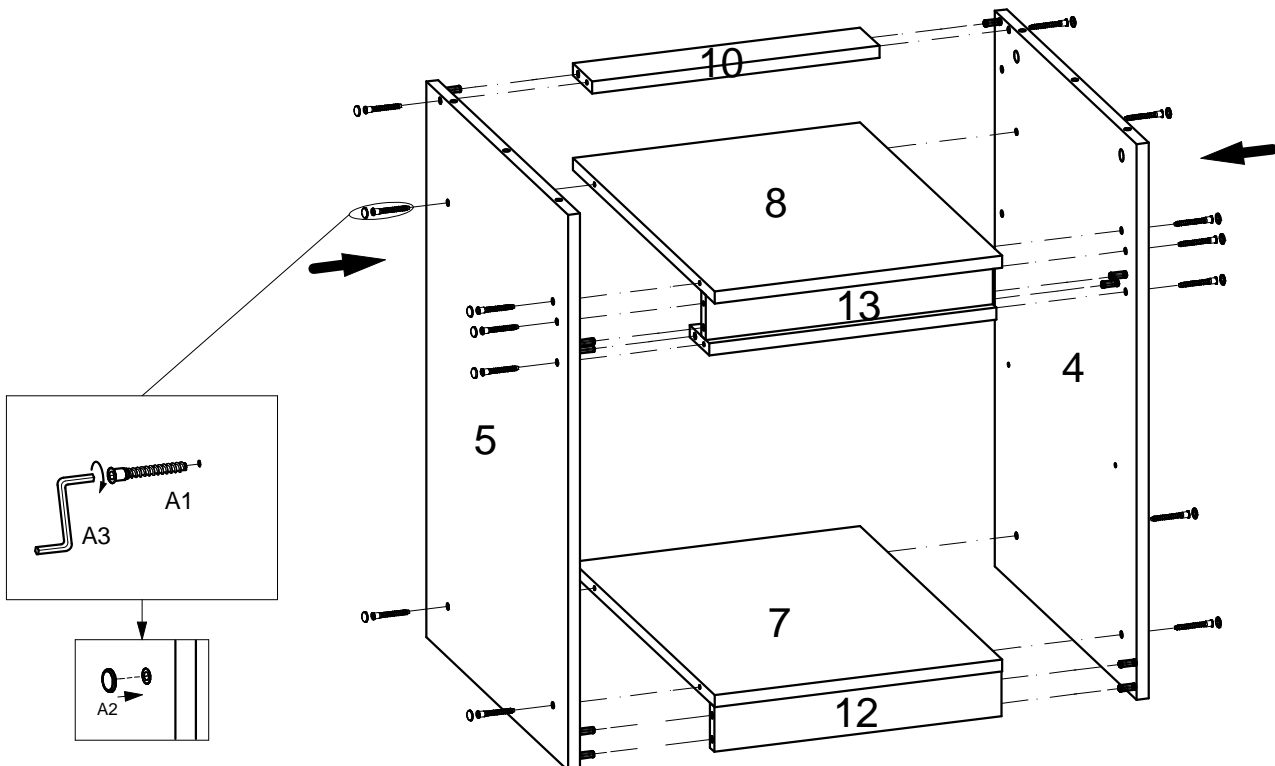
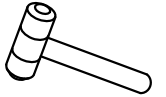

9

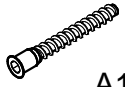

A1 x 4



A2 x 4



A3 x 1

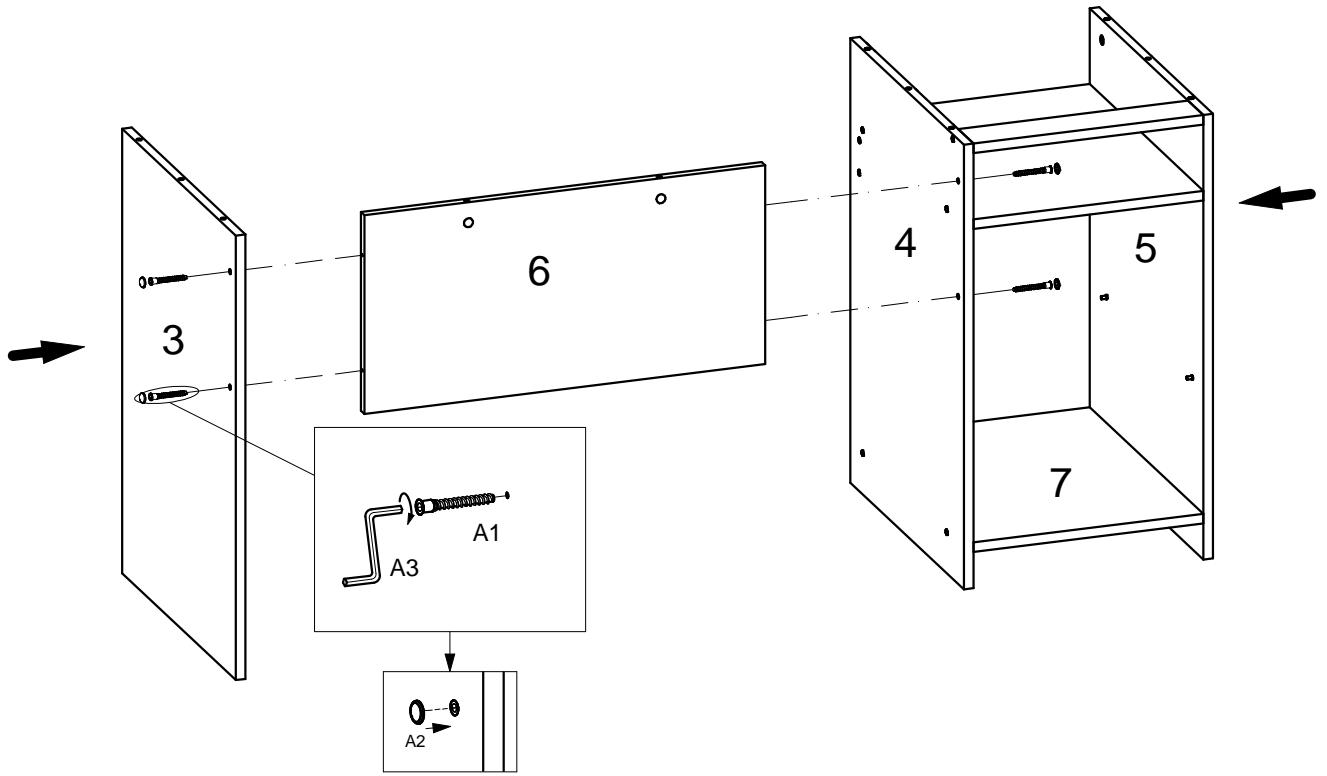

10



B3 x 8

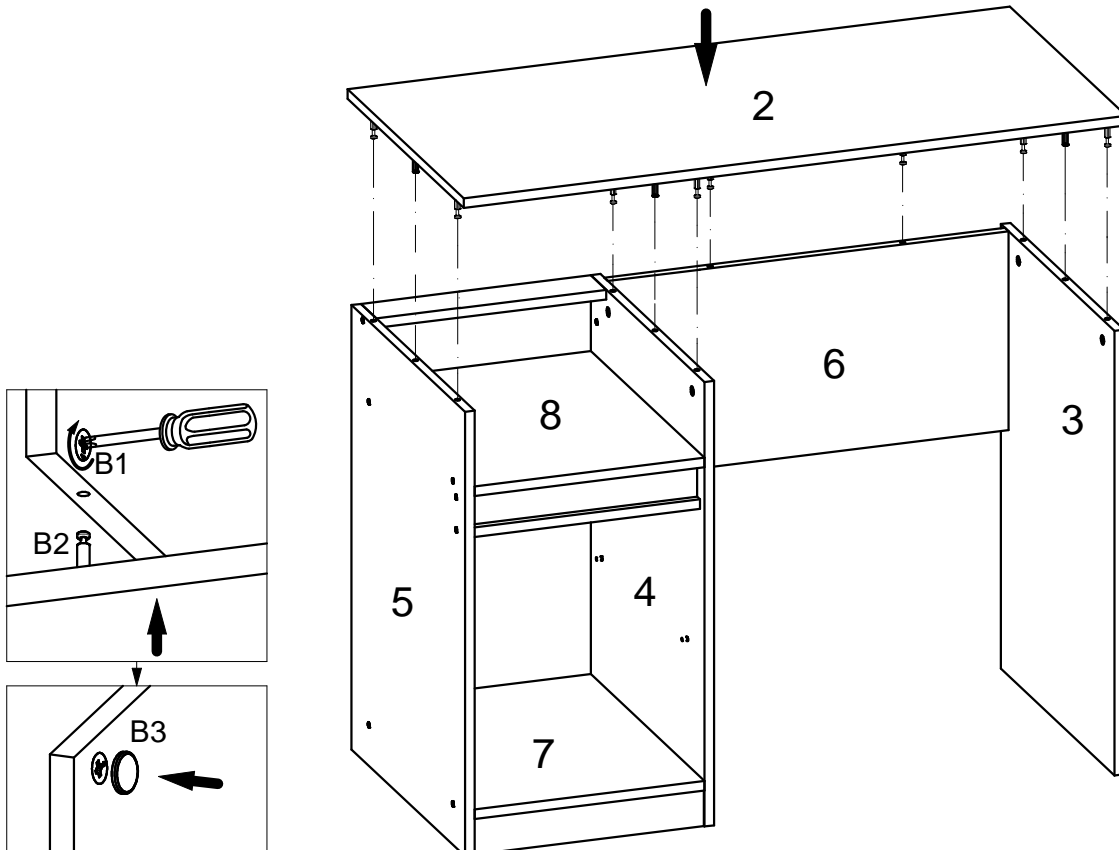
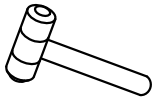

11



D1 x 12



N x 6

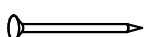

F x 45

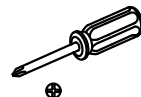
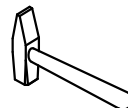

⚠ XX=YY≅90°

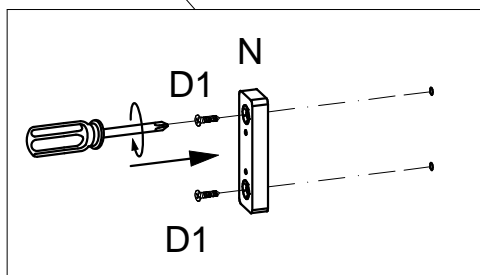
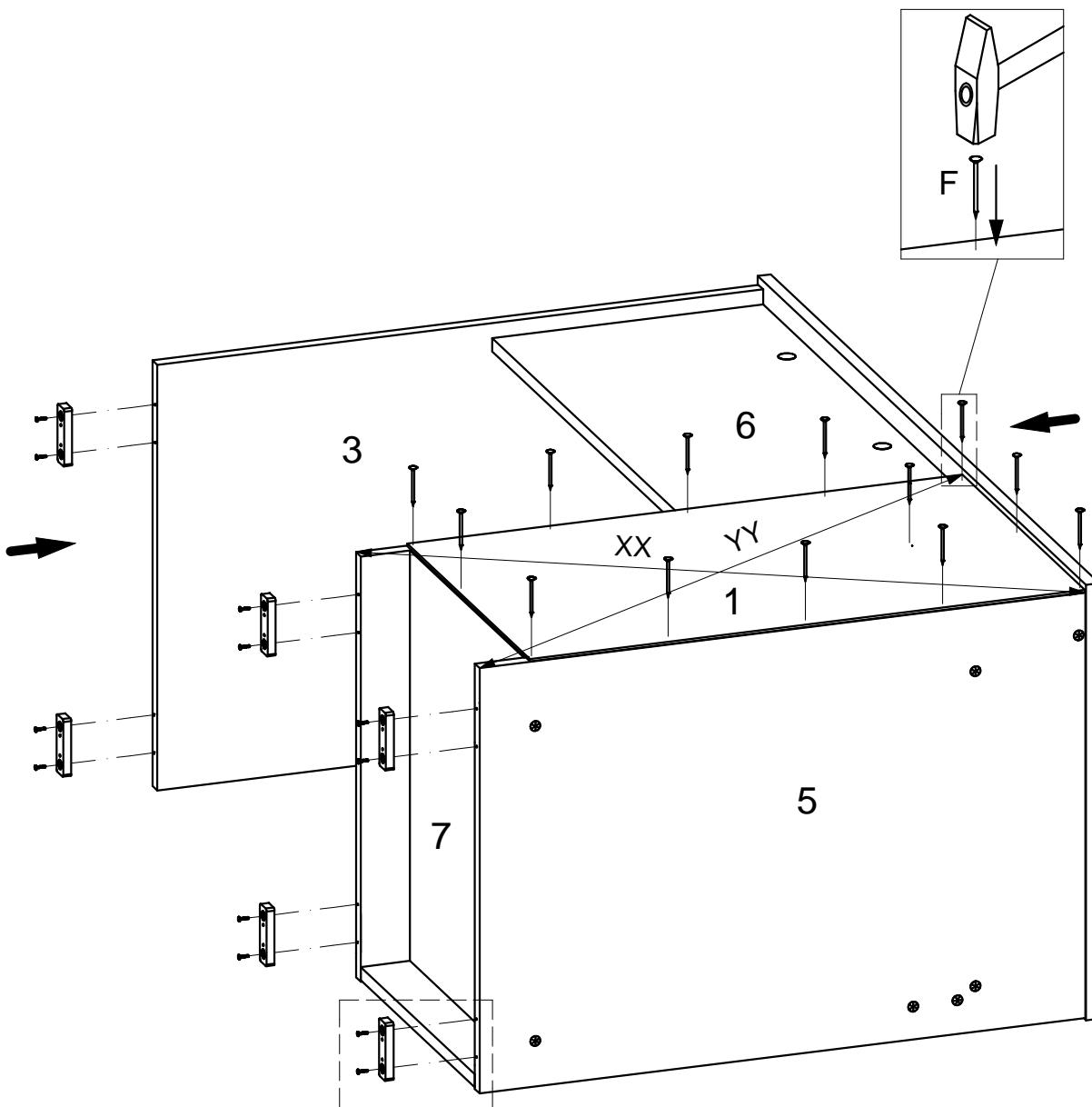

12

